



# FMC640

Professional LTE/GNSS  
terminal

Quick Manual  
v1.7

# Table of Contents

<b>Know your device</b> .....	<b>3</b>
Pinout.....	4
<b>Wiring scheme</b> .....	<b>5</b>
<b>Set up your device</b> .....	<b>6</b>
How to insert Micro-SIM card and connect the battery.....	6
PC Connection (Windows).....	7
How to install USB drivers (Windows).....	7
Configuration (Windows) .....	7
Quick SMS configuration.....	9
<b>Mounting recommendations</b> .....	<b>10</b>
<b>LED indications</b> .....	<b>11</b>
<b>Characteristics</b> .....	<b>11</b>
Basic characteristics .....	11
Electrical characteristics.....	13
<b>Safety information</b> .....	<b>14</b>
<b>Certification and Approvals</b> .....	<b>15</b>

<b>Warranty</b> .....	<b>16</b>
Warranty Disclaimer.....	16

# Know your device

Top view



Top view  
(without cover)

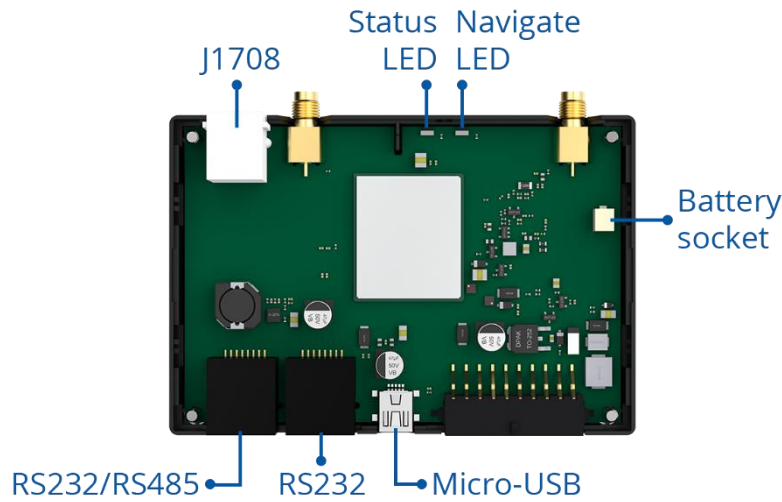

Bottom view  
(without cover)

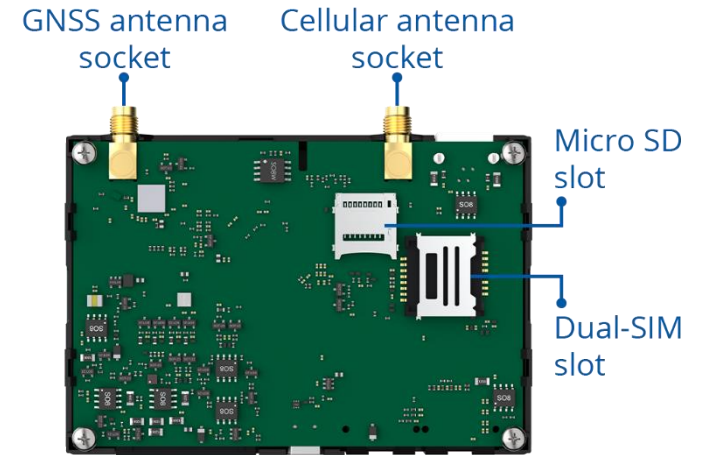

Figure 1 FMC640 device view

# Pinout

PINNUMBER	PINNAME	DESCRIPTION
1	<b>GND (-)</b>	Ground
2	<b>CAN 1L</b>	SAE J1939 CAN interface Low channel 1
3	<b>1WIRE POWER</b>	Power supply pin for Dallas 1-Wire® devices
4	<b>DIN4</b>	Digital input, channel 1
5	<b>DIN2</b>	Digital input, channel 2
6	<b>CAN 2L</b>	SAE J1939 CAN interface Low channel 2
7	<b>AIN2</b>	Analog input, channel 2. Input range: 0-30V/0-10V DC
8	<b>DOUT3</b>	Digital output. Open collector output
9	<b>DOUT2</b>	Digital output. Open collector output
10	<b>AIN3</b>	Analog input, channel 3. Input range: 0-30V/0-10V DC
11	<b>VCC (+)</b>	Power supply (+10-30 V DC)
12	<b>CAN 1H</b>	SAE J1939 CAN interface High channel 1
13	<b>1WIRE DATA</b>	Data channel for Dallas 1-Wire® devices
14	<b>DIN3</b>	Digital input, channel 3
15	<b>IGN (DIN1)</b>	Digital input, channel 1. DEDICATED FOR IGNITION INPUT
16	<b>CAN 2H</b>	SAE J1939 CAN interface High channel 2
17	<b>AIN1</b>	Analog input, channel 1. Input range: 0-30V/0-10V DC
18	<b>DOUT4/AIN4</b>	Digital output. Open collector output OR Analog input, channel 4. Input range: 0-30V/0-10V DC
19	<b>DOUT1</b>	Digital output. Open collector output
20	<b>K-Line</b>	K-LINE interface for online Tachograph Vehicle Data transfer

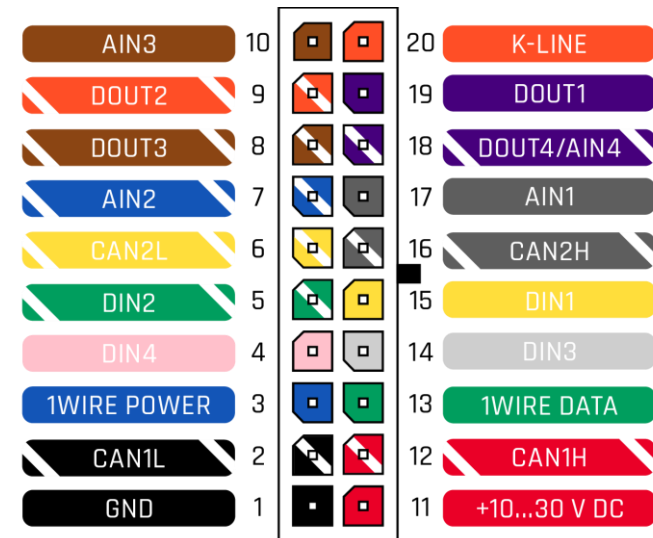

Figure 2 FMC640 pinout

# Wiring scheme

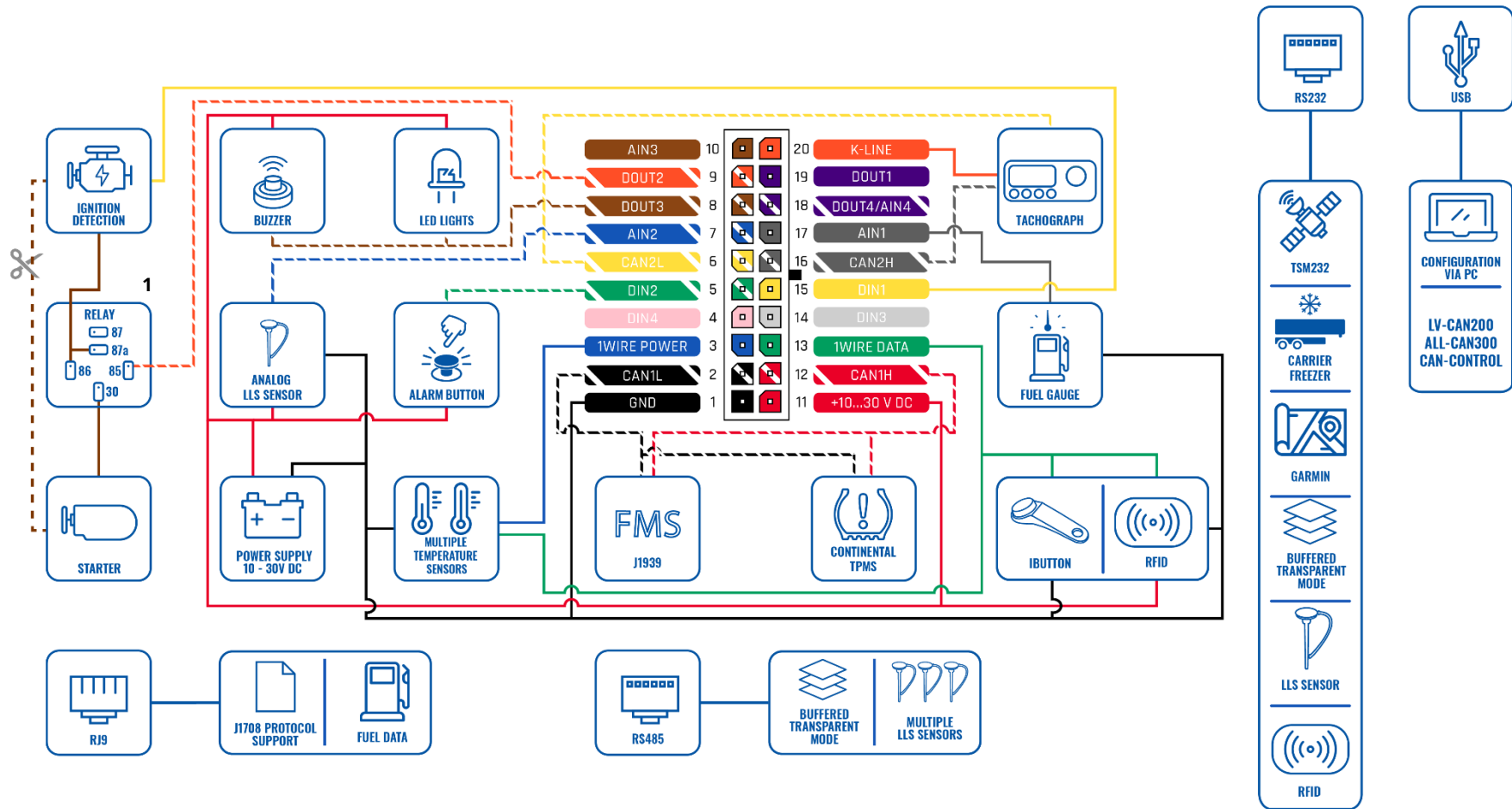

Figure 3 FMC640 Wiring scheme

<sup>1</sup> Automotive relay

# Set up your device

## How to insert SIM card and connect the battery

1. **Unscrew** 4 screws counterclockwise that are located on the **bottom** of the device.
2. Remove the **cover**.
3. Insert **SIM** card as shown with **PIN request disabled** or read [Security info](#) how to enter it later in [Teltonika Configurator](#). Make sure that SIM card **cut-off corner** is pointing forward to slot. **SIM slot 1** is closer to PCB, **SIM slot 2** is the upper one.
4. Connect **battery** as shown to device.
5. After **configuration**, see "[PC Connection \(Windows\)](#)", attach device **cover** back.
6. **Screw** in all screws. Device is ready to be mounted.

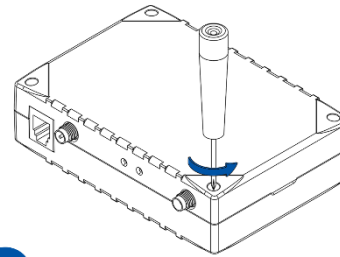

1  
Figure 4 Unscrew screws

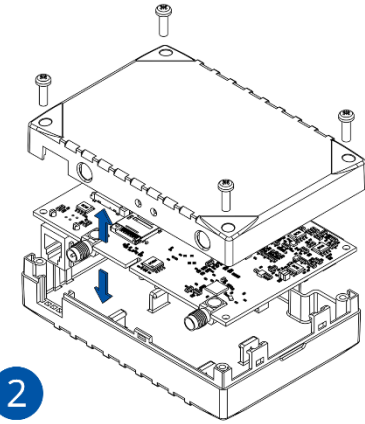

2  
Figure 5 Cover removal

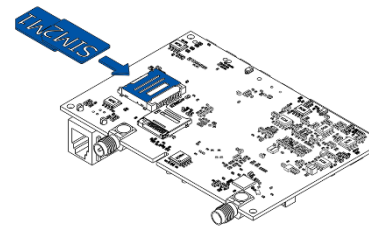

3  
Figure 6 SIM card insert

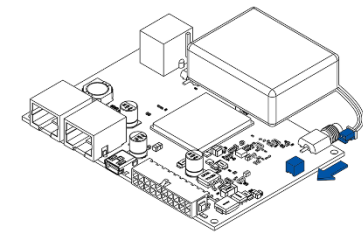

4  
Figure 7 Battery connection

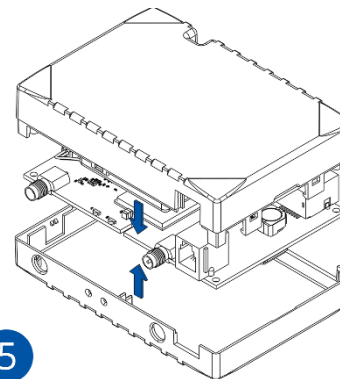

5  
Figure 8 Attaching cover back

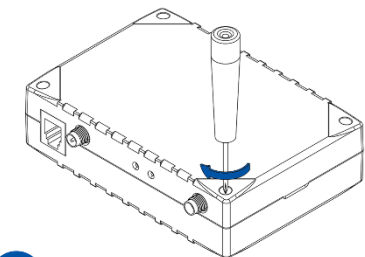

6  
Figure 9 Device is ready

## PC Connection (Windows)

1. Power-up FMC640 with **DC voltage (10 – 30 V)** power supply using **power wires**. LED's should start blinking, see "[LED indications](#)".
2. Connect device to computer using **Micro-USB cable**:
  - You will need to install USB drivers, see "[How to install USB drivers \(Windows\)](#)"
3. You are now ready to use the device on your computer.

## How to install USB drivers (Windows)

1. Please download COM port drivers from [here](#).
2. Extract and run **TeltonikaCOMDriver.exe**.
3. Click **Next** in driver installation window.
4. In the following window click **Install** button. Setup will continue installing the driver and eventually the confirmation window will appear. Click **Finish** to complete the setup.

## Configuration (Windows)

At first FMC640 device will have default factory settings set. These settings should be changed according to the user's needs. Main configuration can be performed via [Teltonika Configurator](#) software. Get the latest **Configurator** version from [here](#). Configurator operates on **Microsoft Windows OS** and uses prerequisite **MS .NET Framework**. Make sure you have the correct version installed.

**Table 1 MS .NET requirements**

<b>MS.NET REQUIREMENTS</b>			
Operating system	MS .NET Framework version	Version	Links
Windows Vista Windows 7 Windows 8.1 Windows 10	MS .NET Framework 4.6.2	32 and 64 bit	<a href="http://www.microsoft.com">www.microsoft.com</a>

Downloaded **Configurator** will be in compressed archive. Extract it and launch **Configurator.exe**. After launch software language can be changed by clicking  in the right bottom corner ([Figure 10 Language selection](#)).

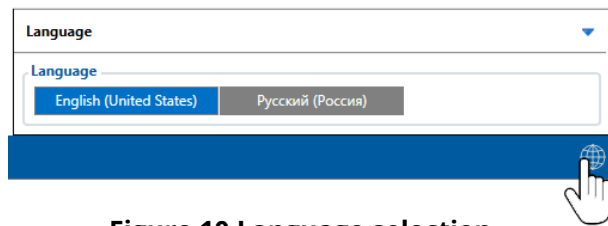

Figure 10 Language selection

Configuration process begins by pressing on connected device (Figure 11 Device connected via USB).



Figure 11 Device connected via USB

After connection to Configurator **Status window** will be displayed (Figure 12 Configurator Status window).

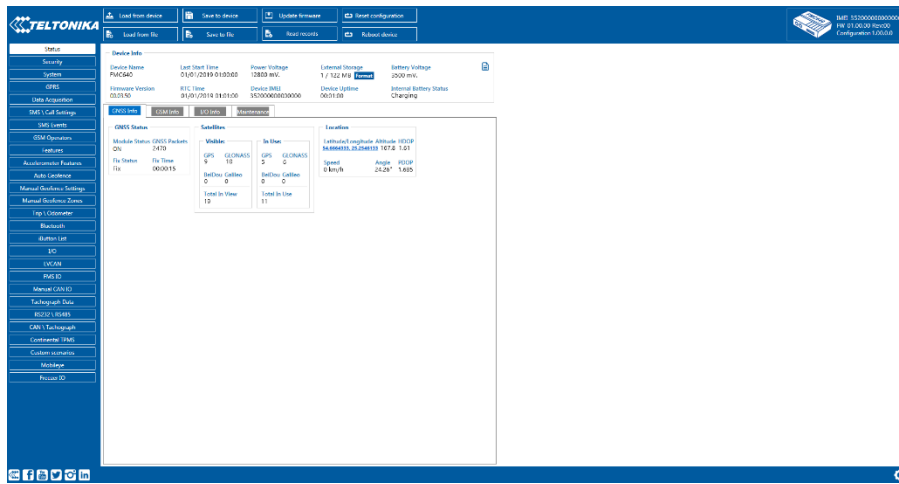

Figure 12 Configurator Status window

Various **Status window** tabs display information about **GNSS**, **GSM**, **I/O**, **Maintenance** and etc. FMC640 has one user editable profile, which can be loaded and saved to the device. After any modification of configuration the changes need to be saved to device using **Save to device** button. Main buttons offer following functionality:

1. **Load from device** – loads configuration from device.
2. **Save to device** – saves configuration to device.
3. **Load from file** – loads configuration from file.
4. **Save to file** – saves configuration to file.
5. **Update firmware** – updates firmware on device.
6. **Read records** – reads records from the device.
7. **Reboot device** – restarts device.
8. **Reset configuration** – sets device configuration to default.

Most important configurator section is **GPRS** – where all your server and **GPRS settings** can be configured and **Data Acquisition** – where data acquiring parameters can be configured. More details about FMC640 configuration using Configurator can be found in our [Wiki](#).



# Quick SMS configuration

Default configuration has optimal parameters present to ensure best performance of track quality and data usage.

Quickly set up your device by sending this SMS command to it:

```
" setparam 2001:APN;2002:APN_username;2003:APN_password;2004:Domain;2005:Port;2006:0;"
```

**Note:** Before SMS text, two space symbols should be inserted.

### GPRS settings:

- 2001 – APN
- 2002 – APN username (if there are no APN username, empty field should be left)
- 2003 – APN password (if there are no APN password, empty field should be left)

### Server settings:

- 2004 – Domain
- 2005 – Port
- 2006 – Data sending protocol (0 – TCP, 1 – UDP)

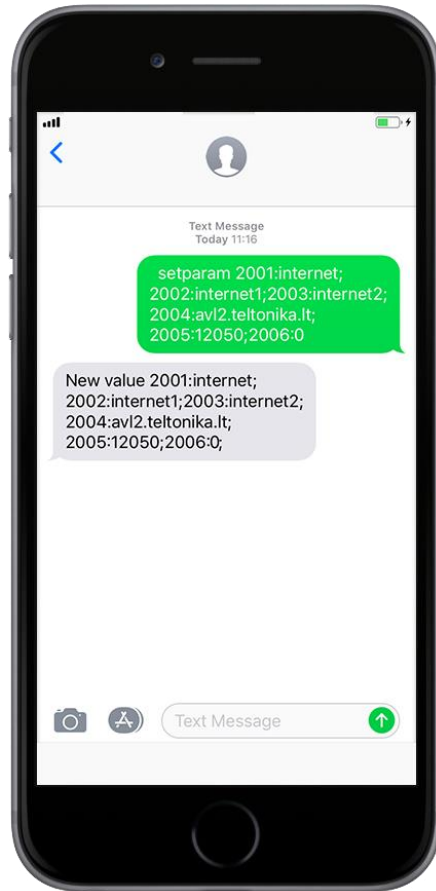

## Default configuration settings

Movement and ignition detection:



Vehicle movement will be detected by accelerometer

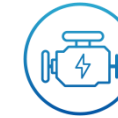

Ignition will be detected by vehicle power voltage between 13,2 – 30 V

Device makes a record **On Moving** if one of these events happen:



300 seconds passes



Vehicle turns 10 degrees



Vehicle drives 100 meters



Speed difference between last coordinate and current position is greater than 10 km/h

Device makes a record **On Stop** if:



1 hour passes while vehicle is stationary and ignition is off

Records sending to server:



If device has made a record it is sent to the server every 120 seconds

After successful SMS configuration, FMC640 device will **synchronize time** and **update records** to **configured server**. Time intervals and default I/O elements can be changed by using [Teltonika Configurator](#) or [SMS parameters](#).

# Mounting recommendations

- Connecting Wires
  - Wires should be connected while module is not plugged in.
  - Wires should be fastened to the other wires or non-moving parts. Try to avoid heat emitting and moving objects near the wires.
  - The connections should not be seen very clearly. If factory isolation was removed while connecting wires, it should be applied again.
  - If the wires are placed in the exterior or in places where they can be damaged or exposed to heat, humidity, dirt, etc., additional isolation should be applied.
  - Wires cannot be connected to the board computers or control units.
- Connecting power source
  - Be sure that after the car computer falls asleep, power is still available on chosen wire. Depending on car, this may happen in 5 to 30 minutes period.
  - When module is connected, be sure to measure voltage again if it did not decrease.
  - It is recommended to connect to the main power cable in the fuse box.
  - Use 3A, 125V external fuse.
- Connecting ignition wire
  - Be sure to check if it is a real ignition wire – power does not disappear while starting the engine.
  - Check if this is not an ACC wire (when key is in the first position, most electronics of the vehicle are available).
  - Check if power is still available when you turn off any of vehicles devices.
  - Ignition is connected to the ignition relay output. As alternative, any other relay, which has power output, when ignition is on, may be chosen.
- Connecting ground wire
  - Ground wire is connected to the vehicle frame or metal parts that are fixed to the frame.
  - If the wire is fixed with the bolt, the loop must be connected to the end of the wire.
  - For better contact scrub paint from the place where loop is connected.



**PAY ATTENTION! Connecting the power supply must be carried out in a very low impedance point of on-board vehicle network. Connecting the GND at an arbitrary point to the mass of the car is unacceptable, as static and dynamic potentials on the line GND will be unpredictable, which can lead to unstable FMC640 operation and even its failure.**

# LED indications

**Table 2 Navigation LED indications**

BEHAVIOUR	MEANING
Permanently switched on	GNSS signal is not received
Blinking every second	Normal mode, GNSS is working
Off	GNSS is turned off because: Device is not working or Device is in sleep mode
Blinking fast constantly	Device firmware is being flashed

**Table 3 Status LED indications**

BEHAVIOUR	MEANING
Blinking every second	Normal mode
Blinking every two seconds	Sleep mode
Blinking fast for a short time	Modem activity
Off	Device is not working or Device is in boot mode

# Characteristics

## Basic characteristics

**Table 4 Basic characteristics**

MODULE	
Name	Quectel EG91-EX
Technology	LTE Cat 1, UMTS, GSM
GNSS	
GNSS	GPS, GLONASS, GALILEO, BEIDOU, SBAS, QZSS, DGPS, AGPS
Receiver	33/99 channel
Tracking sensitivity	-165 dBm
Accuracy	< 3 m
Hot start	< 1 s
Warm start	< 25 s
Cold start	< 35 s
CELLULAR	
Technology	LTE(Cat1)/3G(UMTS/HSPA)/2G(GSM/GPRS)/GNSS
2G bands	EG91-EX: GSM: B3/B8
3G bands	EC91-EX: WCDMA: B1/B8
4G bands	EC91-EX: LTE FDD: B1/B3/B7/B8/B20/B28
Data transfer	LTE: LTE FDD: Max 10Mbps (DL)/Max 5Mbps (UL) UMTS: WCDMA: Max 384Kbps (DL)/Max 384Kbps (UL) GSM: GPRS: Max 107Kbps (DL)/Max 85.6Kbps (UL)
Data support	SMS (text/data)

## POWER

Input voltage range	10 - 30 V DC with overvoltage protection
Back-up battery	550 mAh 8,4V Ni-MH battery
Internal fuse	3 A, 125 V
Power consumption	At 12V < 7 mA ( <a href="#">Deep Sleep</a> ) At 12V < 12 mA ( <a href="#">Online Deep Sleep</a> ) At 12V < 28 mA ( <a href="#">GPS Sleep</a> ) At 12V < 120 mA ( <a href="#">GPRS</a> ) At 12V < 65 mA (nominal with no load) At 12V < 2.5 A Max. (with full Load/Peak)

## INTERFACE

Digital Inputs	4
Digital Outputs	4
Analog Inputs	4
1-Wire temperature sensors	6
1-Wire iButton	1
RS232	2
RS485	1
CAN J1939	2
J1708	1
K-Line	1
LVCAN/ALLCAN	1
GNSS antenna	External High Gain
GSM antenna	External High Gain
USB	2.0 Mini-USB
LED indication	2 status LED lights
SIM	Micro-SIM
SIM	2x SIM Card (Dual-SIM)
Memory	2MB internal flash memory and external SD card up to 32 GB.

## FEATURES

Sensors	Accelerometer
Scenarios	<a href="#">Green Driving</a> , <a href="#">Over Speeding detection</a> , <a href="#">Jamming detection</a> , <a href="#">Excessive Idling detection</a> , <a href="#">Towing detection</a> , <a href="#">Crash detection</a> , <a href="#">Immobilizer</a> , <a href="#">iButton Read Notification</a>
Functionalities	<a href="#">Crash detection</a> , <a href="#">Auto Geofence</a> , <a href="#">Manual Geofence</a> , <a href="#">Trip Detection</a> , <a href="#">Odometer</a> , <a href="#">DDD download and Tacho Online Data</a>
Sleep modes	<a href="#">GPS Sleep</a> , <a href="#">Online Deep Sleep</a> , <a href="#">Deep Sleep</a>
Configuration and firmware update	<a href="#">FOTA Web</a> , <a href="#">FOTA</a> , <a href="#">Teltonika Configurator</a> (USB)
SMS	Configuration, Events, DOUT Control, Debug
GPRS commands	Configuration, Debug, DOUT Control
Time Synchronization	GPS, NITZ, NTP
Fuel monitoring	LLS (Analog), LV-CAN, ALL-CAN, CAN FMS, RS232/RS485 Fuel Sensor, Ultrasonic level sensor
Ignition detection	Digital Input , Accelerometer, External Power Voltage

## PHYSICAL SPECIFICATION

Dimensions	104,1 x 76,8 x 31,5 mm (L x W x H)
Weight	197 g

## OPERATING ENVIRONMENT

Operating temperature (without battery)	-40 °C to +85 °C
Storage temperature (without battery)	-40 °C to +85 °C
Battery Charging temperature	Ta = 20 ± 5 °C (Ambient Temp.)
Battery Discharge temperature	Ta = 20 ± 5 °C (Ambient Temp.)
Battery storage temperature	-20 °C to +45° C
Operating humidity	5% to 95% non-condensing
Ingress Protection Rating	IP41

# Electrical characteristics

**Table 5 Electrical characteristics**

CHARACTERISTIC DESCRIPTION	VALUE			
	MIN.	TYP.	MAX.	UNIT
<b>SUPPLY VOLTAGE</b>				
Supply Voltage (Recommended Operating Conditions)	+10		+30	V
<b>DIGITAL OUTPUT (OPEN DRAIN GRADE)</b>				
Drain current (Digital Output OFF)			120	μA
Drain current (Digital Output ON, Recommended Operating Conditions)			0.5	A
Static Drain-Source resistance (Digital Output ON)		400	300	mΩ
<b>DIGITAL INPUT</b>				
Input resistance (DIN1)	15			kΩ
Input resistance (DIN2)	15			kΩ
Input resistance (DIN3)	15			kΩ
Input resistance (DIN4)	15			kΩ
Input voltage (Recommended Operating Conditions)	0		Supply voltage	V
Input Voltage threshold (DIN1, DIN2, DIN3, DIN4)		7.5		V

## ANALOG INPUT

Input Voltage (Recommended Operating Conditions), Range 1	0		+10	V
Input resistance		120		kΩ
Input Voltage (Recommended Operating Conditions), Range 2	0		+30	V
Input resistance		147		kΩ

## 1-WIRE

Supply voltage	+3.3		+3.9	V
Output inner resistance		7		Ω
Output current ( $U_{OUT} > 3.0$ V)		30		mA
Short circuit current ( $U_{OUT} > 0$ V)		75		mA

## CAN INTERFACE

Internal terminal resistors CAN bus		120		Ω
Differential input resistance	19	30	52	kΩ
Recessive output voltage	2	2.5	3	V
Differential output voltage	0.5	0.7	0.9	V
Common mode input voltage	-30		30	V

# Safety information

This message contains information on how to operate FMC640 safely. By following these requirements and recommendations, you will avoid dangerous situations. You must read these instructions carefully and follow them strictly before operating the device!

- The device uses SELV limited power source. The nominal voltage is +12 V DC. The allowed voltage range is +10...+30 V DC.
- To avoid mechanical damage, it is advised to transport the device in an impact-proof package. Before usage, the device should be placed so that its LED indicators are visible. They show the status of device operation.
- When connecting the 2x10 connector cables to the vehicle, the appropriate jumpers of the power supply of the vehicle should be disconnected.
- Before dismantling the device from the vehicle, the 2x10 connector must be disconnected.
- The device is designed to be mounted in a zone of limited access, which is inaccessible to the operator. All related devices must meet the requirements of EN 62368-1 standard.
- The device FMC640 is not designed as a navigational device for boats.



**Do not disassemble the device. If the device is damaged, the power supply cables are not *isolated* or the isolation is damaged, DO NOT touch the device before unplugging the power supply.**



**All wireless data transferring devices produce interference that may affect other devices which are placed nearby.**



**The device must be connected only by qualified personnel.**



**The device must be firmly fastened in a predefined location.**



**The programming must be performed using a PC with autonomic power supply.**



**Installation and/or handling during a lightning storm is prohibited.**



**The device is susceptible to water and humidity.**

# Certification and Approvals

- [FMC640 CE / RED](#)
- [FMC640 E-Mark](#)
- [FMC640 REACH](#)
- [FMC640 Declaration of IMEI assignment](#)
- [FMC640 Declaration of device operation temperature](#)

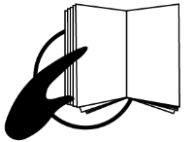

This sign on the package means that it is necessary to read the User's Manual before your start using the device. Full User's Manual version can be found in our [Wiki](#).



This sign on the package means that all used electronic and electric equipment should not be mixed with general household waste.



Hereby, Teltonika declare under our sole responsibility that the above described product is in conformity with the relevant Community harmonization: European Directive 2014/53/EU (RED).

# Warranty

TELTONIKA guarantees its products to be free of any manufacturing defects for a period of **24 months**. With additional agreement we can agree on a different warranty period, for more detailed information please contact our sales manager.

Contact us [teltonika-iot-group.com/about-us/contacts/](https://teltonika-iot-group.com/about-us/contacts/)

**All batteries carry a reduced 6 month warranty period.**

If a product should fail within this specific warranty time, the product can be:

- Repaired
- Replaced with a new product
- Replaced with an equivalent repaired product fulfilling the same functionality
- TELTONIKA can also repair products that are out of warranty at an agreed cost.

# Warranty Disclaimer

**TELTONIKA PRODUCTS ARE INTENDED TO BE USED BY PERSONS WITH TRAINING AND EXPERIENCE. ANY OTHER USE RENDERS THE LIMITED WARRANTIES EXPRESSED HEREIN AND ALL IMPLIED WARRANTIES NULL AND VOID AND SAME ARE HEREBY EXCLUDED. ALSO EXCLUDED FROM THIS LIMITED WARRANTY ARE ANY AND ALL INCIDENTAL OR CONSEQUENTIAL DAMAGES INCLUDING BUT NOT LIMITED TO, LOSS OF USE OR REVENUE, LOSS OF TIME, INCONVENIENCE OR ANY OTHER ECONOMIC LOSS.**

More information can be found at [teltonika-iot-group.com/warranty-repair/](https://teltonika-iot-group.com/warranty-repair/)